

Industrial Magnets



since 1991

PENTAGON

Întotdeauna Soluția Potrivită

Pentagon Ltd. is a company with wholly private capital, established in 1991, which promotes and sells high-performance products, as a representative and distributor of companies with a long history and tradition at national and international level.

We are a forward-thinking, flexible company with prudent development and a capable team of specialists to always offer complete technical solutions at a very good price / quality ratio.

Having a range of products with a wide range of uses in all branches of industry and construction, we had the possibility to collaborate with many companies in the country.

In order to keep you informed on the evolution and strategy of our company, we regularly participate in fairs and local and national exhibitions, we distribute catalogs and leaflets, we support an online promotion campaign and we support directly through area representatives.

We have the following trademarks:

“Pentagon Romania”, “PTG”, “Terentex”, “Teraweld”, “Întotdeauna Soluția Potrivită” and logo



Our company has implemented and applies the Quality Management System: ISO 9001-2015



Benefits, safety and sustainability.	4
Welding & Fabrication	6
Material Handling	38
Material Alignment	46
Lifting Tools	52
Heavy Lifting Solutions	58
Woodworking	70
Automation solutions	84
Article number index	86



Benefits

- 100% Fail-safe technology
- True On/Off
- Magnet stays clean
- Magnets do not require an electrical power source
- Stronger & scalable force allows a better control
- Precise positioning

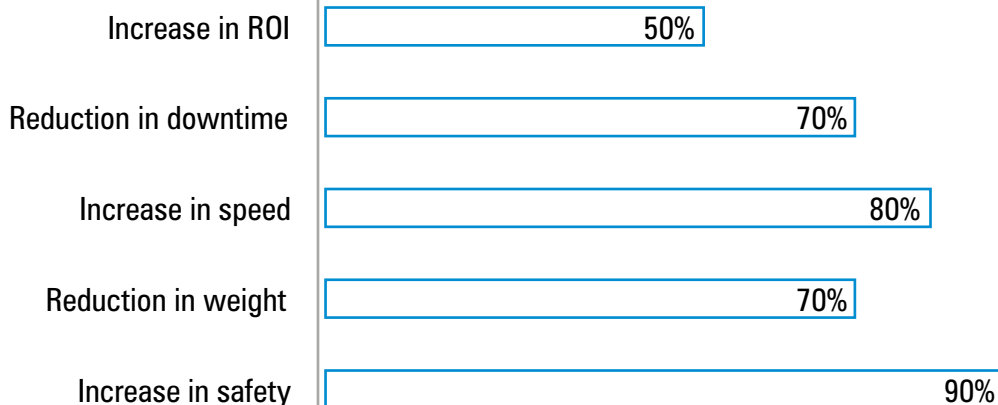

Our success

Safety



We consider safety in everything we do.

If you work around steel, safety is the first consideration.
Fewer hands on the job touching steel means a safer workplace.
Safety is crucial to these products – easy actuation, lighter lifting,
stability control and lift-to-shear capabilities all tie back to an emphasis on safety.



Our supplier has evolved from manufacturing magnetic tools to engineering innovative solutions to increase safety, productivity and efficiency in industries such as automotive, manufacturing, heavy industry and consumer goods.

“To lead globally in automated magnetic solutions by applying disruptive technology across industries while providing high quality design, engineering, customer service and support.”



These products has a green technology utilizing the enduring power of rare earth magnets with low energy consumption.



Sustainability

This welding and fabrication tools are designed to drive and increase productivity for professionals and hobbyists at the same time. Use these versatile magnets to position the workpiece, create reproduceable angles, hold the pieces in place and more - there are no limitations. The product range is completed with ground clamps, removing the need to weld and remove wedges to let current flow away and create an outstanding welding result.

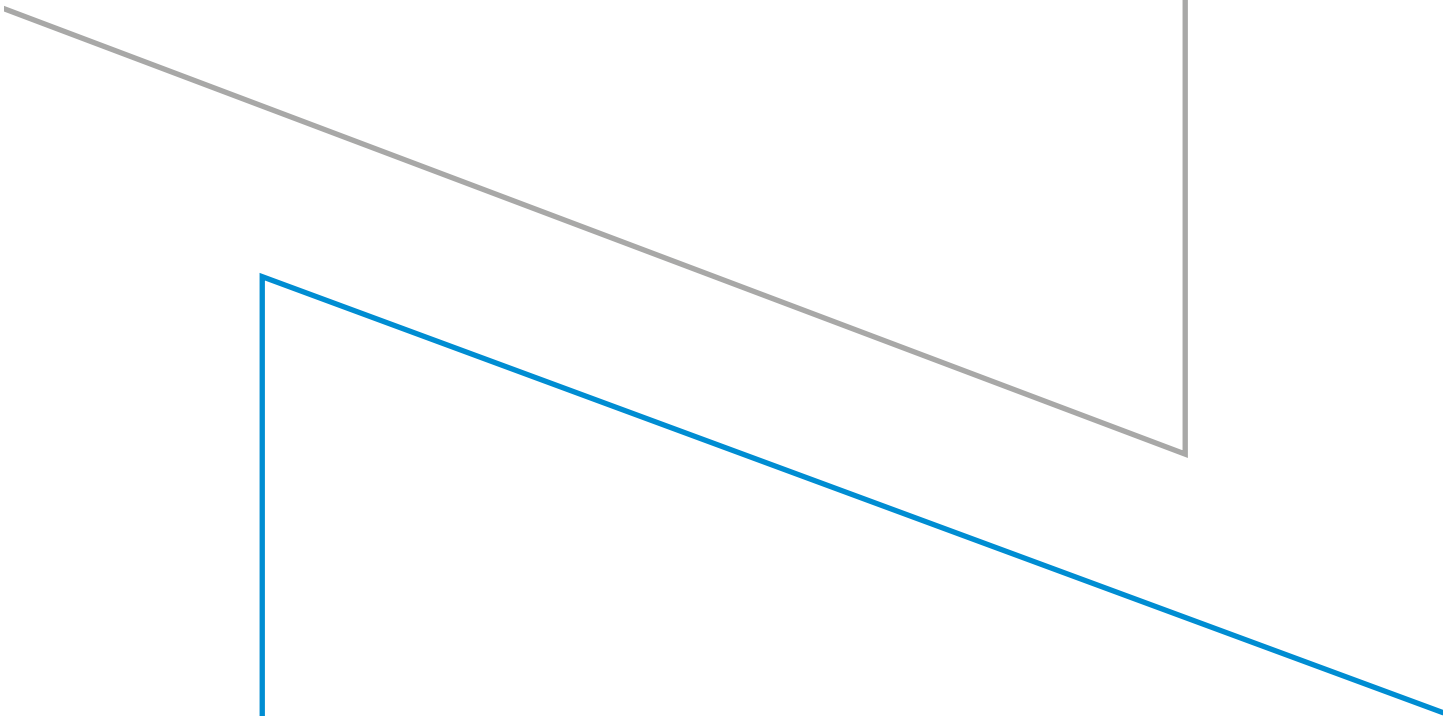

MagSquares

Applications: Fixturing, Workholding, Mounting

The most versatile workholding and fixturing tool ever! Align and secure flat or round pieces of steel to fabricate angles. Pull corners, secure steel for cutting, use as a guide, make your own fixtures and more.

- Multiplane magnetic grip on 5 sides
- Machined at 90° with pre-tapped holes for mounting
- Mounts anywhere - no limitations like clamps
- Holds flat and round surfaces of steel



High Heat variants available!



8100494

	Part No.	Max. Breakaway (N)	Height (mm)	Width (mm)	Length (mm)	Weight (kg)
MagSquare 165	8100494	666,8	64,3	31	48	0,3
MagSquare 400	8100238	1775	90,3	41,3	64	0,9
MagSquare 600	8100106	2696,8	105,4	51,5	75	1,5
MagSquare 1000	8100099	4677,7	146,9	72	108	3,6



MagMounts

Applications: Mounting, Hanging

Perfect for an easy movement and placement of a tool! Strong magnetic hold force with a single on and off lever. The top of the tool is ready for mounting a variety of accessories.

- Fixed bar magnet is for flat steel
- Swivel bar magnet is for round an uneven shapes
- Multiple threaded holes on the top
- Perfect for top mount tools, measuring and security devices
- Holds flat and round surfaces of steel

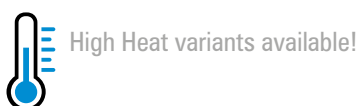

High Heat variants available!



	Part No.	Max. Breakaway (N)	Height (mm)	Width (mm)	Length (mm)	Weight (kg)
MagMount 60 Keychain	81001291	266,75	30	20	58,7	0,07
MagMount 150	8100579	460,9	40	55,4	78,2	0,4
MagMount 235	8100451	961	44,2	97,7	68,1	0,5
MagMount 235 UH	8100695	961	44,2	97,7	68,1	0,5
MagMount 300	8100595	1088,5	43,8	104,4	134,9	0,5
MagMount 300 UH	8100696	1088,5	43,8	104,4	134,9	0,5
MagMount 400	8100523	1873	65	82,3	116	1,1
MagMount 600	8100580	2324,2	71	104,4	120	1,6
MagMount 1100	81001397	4893,5	59,8	283,5	110,9	4,3

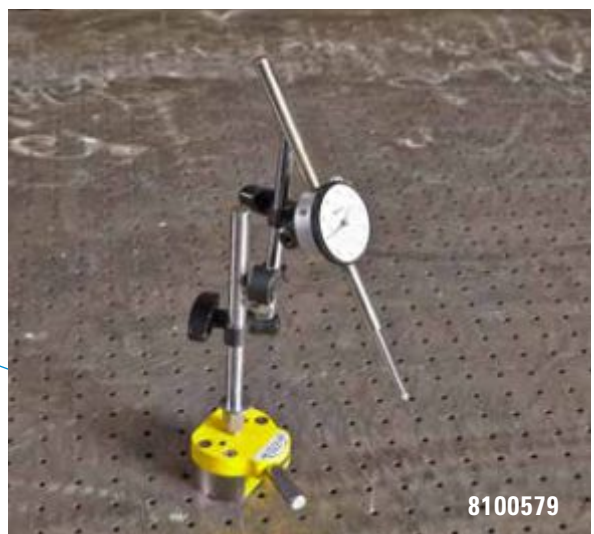
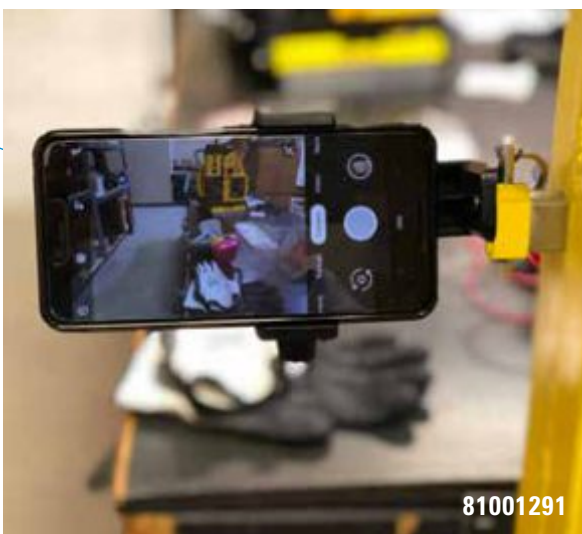

Ground Clamps

Applications: Grounding, Welding

New temperature lowering fin design!

No more tacking necessary. Simply place it on a clean work surface, turn on and start welding.

- Fast setup as it instantly grounds to flat and round surfaces of steel
- Stronger hold in the shear (vertical) position allows for use with heavy gauge cable
- No more tacking on tabs and searching for ground location
- New fin design lowers temperature by 26%



High Heat variants available!



8100746

	Part No.	Max. Breakaway (N)	Height (mm)	Width (mm)	Length (mm)	Weight (kg)
300 Amp	8100746	402	57,3	49	73,1	0,4
600 Amp	8100747	872,8	65,5	78,5	105,6	0,8
800 Amp	8100552	1333,7	73,9	98,6	125,6	1,6

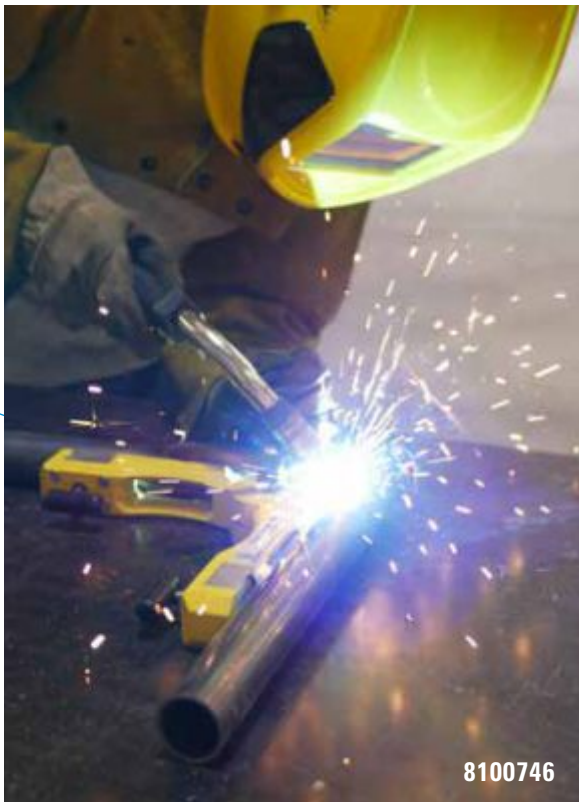

MagWheels

Applications: Fitting, Positioning, Guiding, Fixturing, Pipe Handling

MagWheels have a powerful connection to drive units on any ferrous surface enabling flat, vertical or inverse travel. Ideal for positioning and guiding, sheet feeding, pipe handling, fitting and fabrication, and numerous OEM automation and fixturing applications.

- Magnetic rotating elements with potential to automate
- Non-marring hold
- Can be fitted with drive units for mobile applications
- Climbing, carrying and driving anywhere above/below magnetic surfaces



8100075

 High Heat variants available!

	Part No.	Max. Breakaway (N)	Height (mm)	Width (mm)	Length (mm)	Weight (kg)
MagWheel 95	8100401	166,7	55,7	41	56,3	0,3
MagWheel 150	8100074	284,4	71,2	52	67,8	1,0
MagWheel 600	8100075	1294,5	121,7	92	101	3,0
MagWheel1000	8100250	2343,8	175	127	180,4	9,0

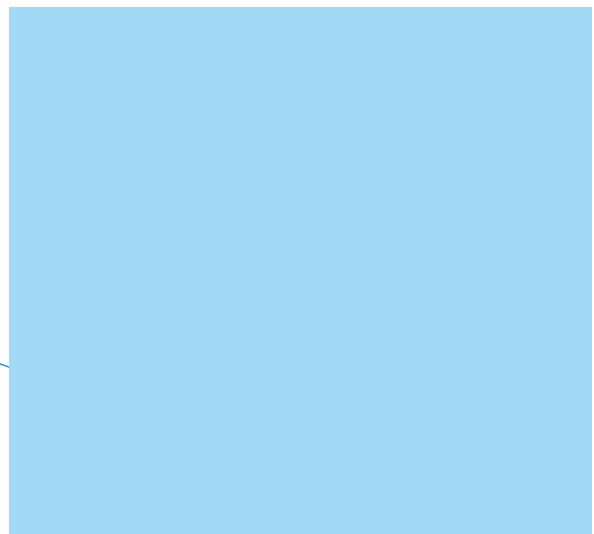
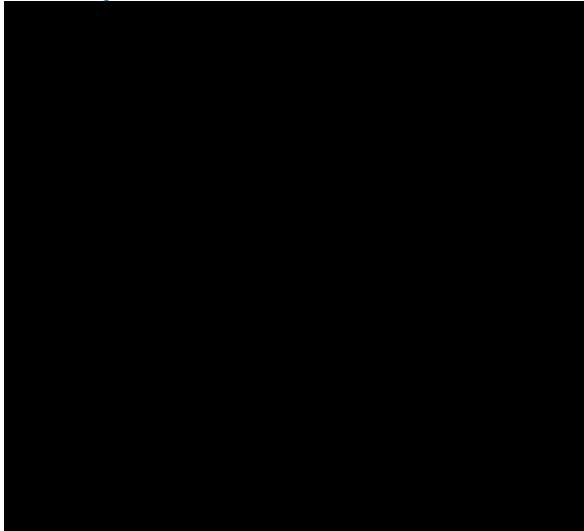

MagTethers

Applications: Underwater Tethering, Welding, Oil & Gas, Military

MagTethers help you tether you or your equipment while working above and below water. It is sealed with a marine grade corrosion resistant coating to hold up to saltwater.

- Safety latch to turn on and off
- Quick connect and disconnect
- Alongside and below the surface mooring
- Noise suppressing coating
- Ideal for underwater tethering, military and commercial oil and gas applications



8100077

	Part No.	Max. Breakaway (N)	Height (mm)	Width (mm)	Length (mm)	Weight (kg)
MagTether 300	8100111	1098,3	107,3	124,4	164	1,0
MagTether 600	8100077	2696,8	127,3	124,4	161	1,8
MagTether 1000	8100051	4677,7	153,4	158,3	194	4,6



Multi Angles

Applications: Fixturing, Welding

Multiple angles in one! Extremely versatile welding and fabrication angle tools.

- Accommodates flat sheets and pipes
- Offers several common angles
- Sturdy and compact
- Holds flat and round surfaces of steel

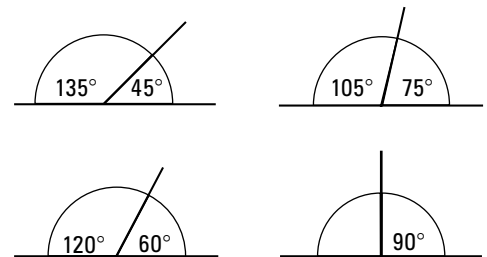

	Part No.	Max. Breakaway (N)	Height (mm)	Width (mm)	Length (mm)	Weight (kg)
Mini Angle	8100352	333,4	53,7	32	59,5	0,2
Multi Angle 400	8100438	912	95,5	65	129	1,2
Mini Multi Angle	8100350	333,4	65,7	32	72,3	0,2
Mini Multi Angle with 300 Amp Ground Clamp	8100351	333,4	86,3	42	90,5	0,4



MagVises

Applications: Fixturing, Welding

MagVises that you don't have to bolt in place! Perfect for drilling, cutting, grinding and beveling small to medium size pieces.

- Offers 45/135°, 60/120°, 75/105° and 90° angles
- Doubles as multi-angle work holding tool
- Vise options include round, angle stock, square bar or flat
- Holds flat and round surfaces of steel

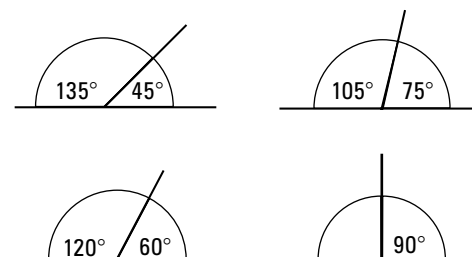

	Part No.	Max. Breakaway (N)	Height (mm)	Width (mm)	Length (mm)	Weight (kg)
MagVise 1000	8100450	1833,4	138	110	149,8	4,4
MagVise 1500	8100897	3500,9	161	152,7	179,7	9,6

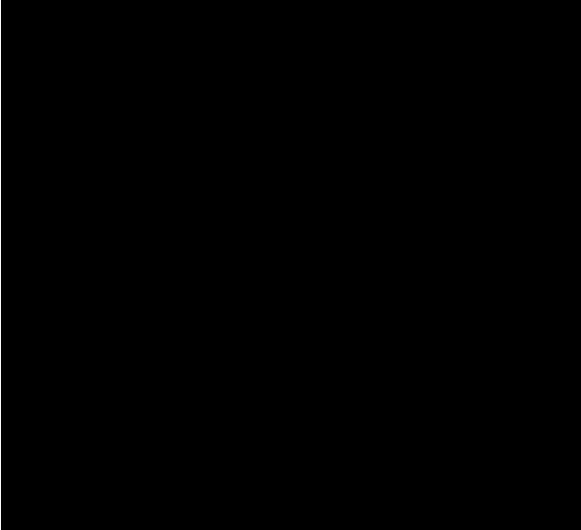

Pivot Angles

Applications: Fixturing, Welding

Range of angles: from 0 to 270 degrees with 5 degree indicators and detents.

Two sides of the tool magnetize when turned on and can be secured to a table or wall to hold a fixture in place.

- Single lock at the elbow to secure your angle
- Dial on elbow has indicators every 5 degrees
- Detents at every 45 degrees for rapid adjustment
- Holds flat and round surfaces of steel



81001269

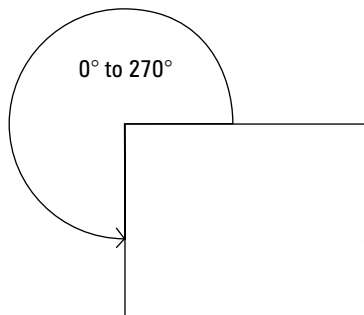

81001269 &
81001215

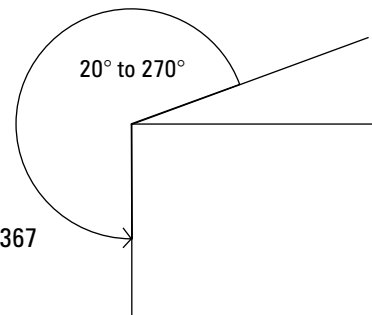

8100367

	Part No.	Max. Breakaway (N)	Height (mm)	Width (mm)	Length (mm)	Weight (kg)
Pivot Angle 150 Mini	81001269	578,6	210	72,5	210	1,5
Pivot Angle 150 Max	81001215	814	53,4	66,0	215,5	1,5
Pivot Angle 200	8100367	961	44,45	70	38	1,63



8100367



81001269



81001215 & 81001269



81001215



8100367



81001215

90 Degree Angles

Applications: Fixturing, Welding

The 90° Angles deliver superior accuracy, efficiency and speed at a fixed 90° welding angle. Simply adjust the MagSquares by sliding them up or down on each axis for unmatched versatility.

- Lightweight with incredible strength
- Precision positioning
- MagSquares can be reversed on each axis
- Holds to flat and round surfaces of steel

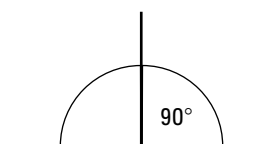

	Part No.	Max. Breakaway (N)	Height (mm)	Width (mm)	Length (mm)	Weight (kg)
90° Angle 165	8100548	539,4	205	76,8	205	0,8
90° Angle 400	8100454	1784,8	287	89,3	287	2,8
90° Angle 600	8100495	2696,8	287	100	287	3,7
90° Angle 1000	8100503	4677,7	287	146,6	474	4,6



Boomer Angles

Applications: Fixturing, Welding

Boomer Angles feature a rotating MagSquare at each axis which provides virtually unlimited angles including a preset for 90-degree holding. Easy on and off by rotating the black knobs.

- Adjustable angle holds
- Position for odd angles in seconds
- Non-marring hold
- Holds flat and round surfaces of steel

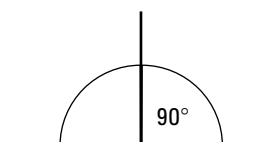

	Part No.	Max. Breakaway (N)	Height (mm)	Width (mm)	Length (mm)	Weight (kg)
Boomer Angle 150	8100091	480,5	190,5	76,2	190,5	1,3
Boomer Angle 400	8100453	912	254	66	279,4	3,1
Boomer Angle 600	8100090	2696,8	257,5	164,3	258	4,4



Hand Lifters

Application: Lifting

Single and Dual Hand Lifters safely pick up hot, sharp or dirty steel with our strong magnets. An ergonomic fixed handle and a lever locking mechanism prevent accidental release.

- Holds flat and round surfaces of steel
- Lightweight and easy to use
- Shallow field magnets allow for de-stacking of thin material
- Adjustability range length allows for versatile uses



8100810

	Part No.	Max. Breakaway (N)	Height (mm)	Width (mm)	Length (mm)	Weight (kg)
Fixed Hand Lifter 235	8100795	961	105	124,3	175,4	0,7
Fixed Hand Lifter 400	8100810	1667,1	127	124,3	175,4	1,1
Dual Hand Lifter 235	8100821	1922,1	111,4	184,8	583,8	1,9
Dual Hand Lifter 400	8100822	3344	133,3	184,8	583,8	2,7

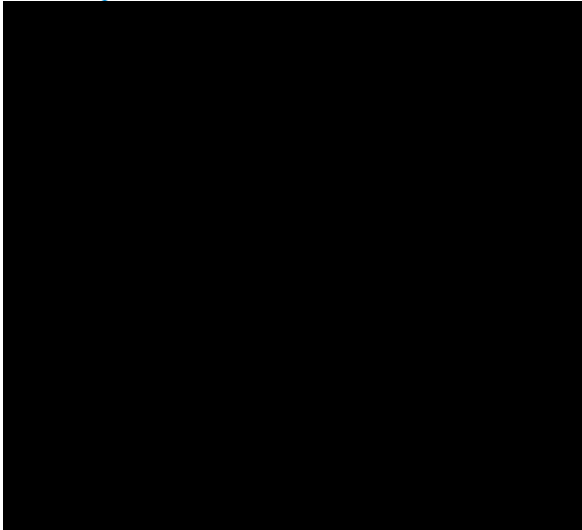

Hand Lifters 60M

Hand Lifter 60M is a manual on and off magnetic hand lifter great for dragging sheet and all your small steel handling needs.

- Holds flat and round surfaces of steel
- Pivot handle with multi settings (for sheet dragging) or locking handle vertical for use as a hand lifter
- No need to manhandle steel or fight magnets in moving steel



8100359

	Part No.	Max. Breakaway (N)	Height (mm)	Width (mm)	Length (mm)	Weight (kg)
Hand Lifter 60 M	8100359	961	140	60	134,3	0,7



Hand Lifter 60CE

Get more control with the use of only one hand! Lift and release steel with just the push of a button.

- Holds flat and round surfaces of steel
- 100% duty-cycle-magnet can stay on forever
- Battery strength indicator light
- Recharges in 20 minutes
- Batteries have 2000 actuations per charge
- Includes charger and 2 rechargeable batteries



8100487

	Part No.	Max. Breakaway (N)	Height (mm)	Width (mm)	Length (mm)	Weight (kg)
Hand Lifter 60 CE	8100487	879,7	134,6	61	134,6	1,1



MagYoke

Applications: Weld Joints, Magnetic Particle Inspection

Gives you the ability to perform magnetic particle inspection without an electrical power source. It has all the advantages of a permanent Yoke system without the problems related to adhesion of metal particles.

- Non-destructive testing of weld joints
- Full Yoke system testing capabilities
- Off position allows tool to easily be removed from material
- Significantly reduces metal to metal sparking
- Lightweight and compact



8100551

	Part No.	Max. Breakaway (N)	Height (mm)	Width (mm)	Length (mm)	Weight (kg)
MagYoke	8100551	431,5	165	38	139,7	2,7



8100551



8100551



8100551

MagHooks

Applications: Utility Hooks, Welding, Fabricating

Need a helping hand? Organize your workspace with our magnetic hook!

- Instantly attaches to flat and round surfaces
- Locking hand for safety
- Lightweight and reliable
- Convenient and easy move from job to job



8100012

	Part No.	Max. Breakaway (N)	Height (mm)	Width (mm)	Length (mm)	Weight (kg)
MagHook 25	8100012	509,9	89,3	40	47,4	0,2
MagHook 40	8100006	902,2	103	69	69	0,8



Drive speed and efficiency when handling ferromagnetic materials such as pipes, flat steel, hot and dirty tools or simply avoid contact with sharp edges by handling the workpiece with handling tools. Place the part, turn the magnets on and handle your parts safely.

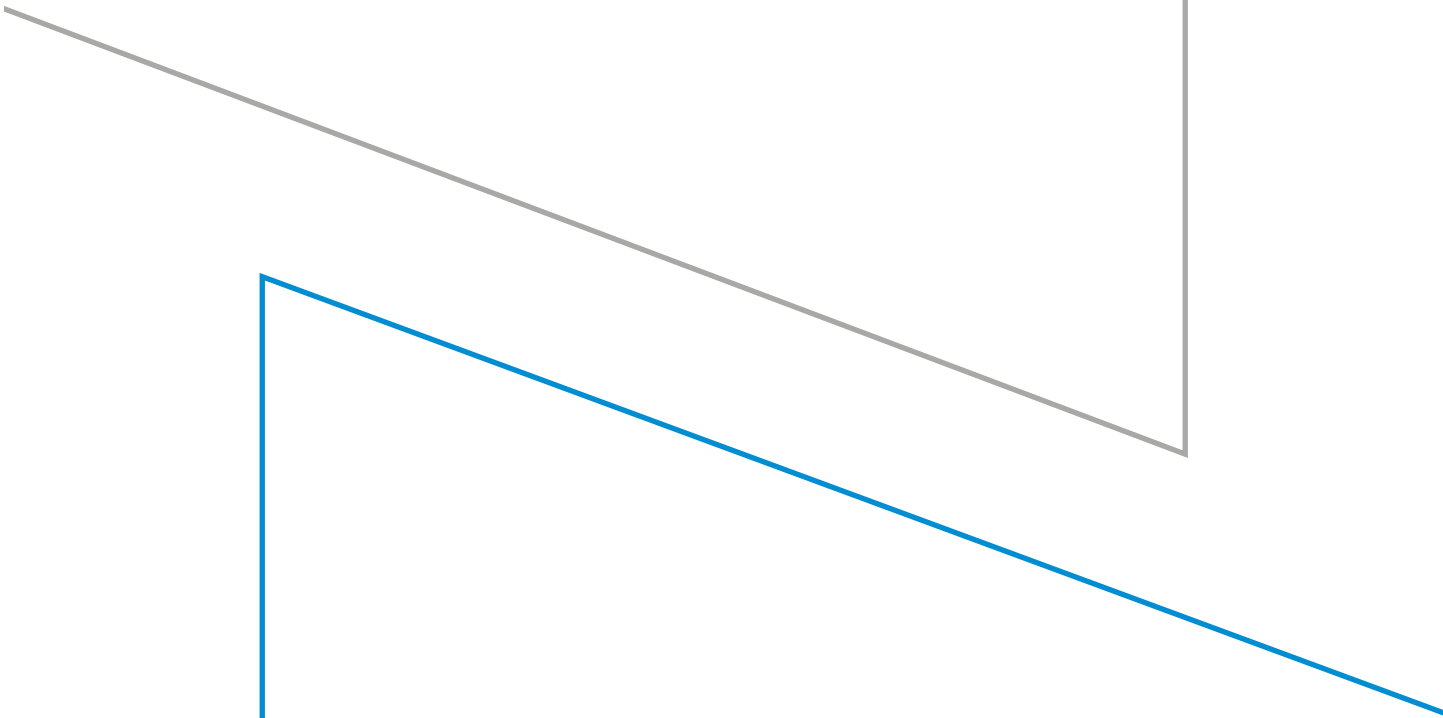

Extenda Lifts

Applications: Lifting Valve Box, Lifting Small Lids, Infrastructure and Utility Jobs

Pick up and move steel without bending over and using your hands!
Safely lift a valve box with ease as well as hot, sharp or dirty steel without touching it.

- Instantly attaches to and removes valve box covers
- Our safety lock keeps magnets on until they're turned off
- Precise positioning
- Lightweight and compact
- Ideal for cities and utilities, valve box and small lid removal



8130177

	Part No.	Max. Breakaway (N)	Height (mm)	Width (mm)	Length (mm)	Weight (kg)
Extenda-Lift 600	8100025	2128	716,5	100	102,3	2,4
Extenda-Lift 1000	8130177	4677,7	744,2	127	127	4,4



MagDolly & Beam Jacks

Applications MagDolly: Lifting Manhole Covers, Infrastructure and Utility Jobs

No more getting down on your knees or pinching your fingers to move heavy manhole covers! This collapsible Dolly helps you lift and carry heavy sheets, pipes or any steel objects.

- Safer for your back, knees and hands
- Allows one person to move heavy objects
- Fast and easy setup
- Sturdy and reliable
- Maintains control and stays clean
- Maneuvers on uneven surfaces
- Compatible with lifting magnets, sold separately

Applications Beam Jacks: Shipbuilding, Closing gaps in Weldments, Leveling, Bending

The Aluminum adjustable Beam Jacks are suitable for pulling ferrous steel flat against stiffener beams, eliminating air gaps to improve welding efficiency.

- Instantly attaches to flat and round surfaces
- Lightweight and performs better on thin materials
- Removes air gaps between structural members and base materials

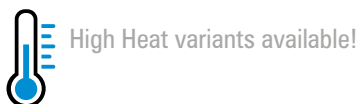

High Heat variants available!

	Part No.	Max. Breakaway (N)	Height (mm)	Width (mm)	Length (mm)	Weight (kg)
MagDolly	8100433	1559,2	1385	348,6	1938,3	25
1,5 Ton Beam Jack	81001245	14700,2	525,8	533,4	457,2	15,1
3 Ton Beam Jack	8800605	30636	881	535,3	633	35,5
6 Ton Beam Jack	81001171	55279,8	887,7	637,5	863	69



MagReach

Applications MagReach: Lifting

The MagReach is a classic no-touch handling tool which eliminates the need to touch sharp, dirty or hot materials. This tool can pull parts off the burn table while standing on the side instead of jumping on top, eliminates the need for bending over and prevents back injuries. The MagReach is excellent for dragging and guiding heavy sheets and tubes with an extendable handle for varying distances.

- Hands off steel: Classic No-Touch tool
- Eliminates the need to touch sharp, dirty or hot materials
- Pulls parts off the burn table while standing on the side
- Excellent for dragging and guiding heavy sheets
- Extendable handle for varying distances
- Multiple working surfaces meant for flat and round material
- Increases productivity and safety in workplaces and production floors



81001322

	Part No.	Max. Breakaway (N)	Height (mm)	Width (mm)	Length (mm)	Weight (kg)
MagReach 400	81001332	1696,6	1283 - 2183	160,5	71	3,0



Especially in Shipyard and large Steel applications, the need to weld and remove wedges, hooks and other guiding elements can completely be avoided by using alignment tools. Our powerful tools allow removing any airgaps and with the MagPress, aligning different beams and sheets before welding them together is easier than ever before.

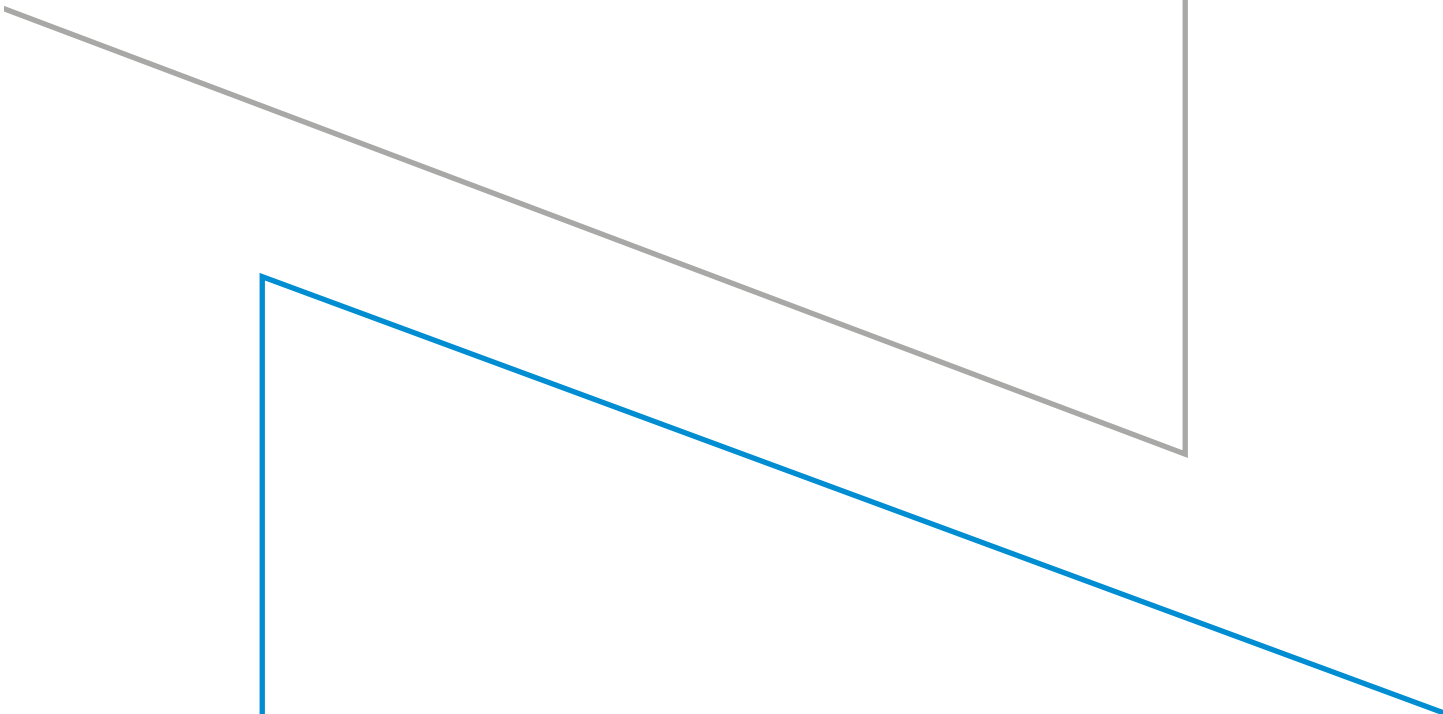

Stiffeners, MagPress

90° Angle Stiffener Applications: Shipbuilding, Fixturing at 90 Degree Angle, Welding

Stiffeners are designed for some serious power, stabilization and precision control for those heavy-duty jobs. The entire side plate is magnetized when turned on.

- Mounts to flat and round surfaces of steel
- Reinforced end caps for superior durability
- Lightweight with incredible strength
- Precise positioning



High Heat variants available!

MagPress Applications: Sheet Alignment, Leveling, Shipbuilding

MagPress aligns large steel sheets with precision.

Equalize high and low points between steel gaps by placing the magnet on low, pry on high and weld.

- Lightweight and compact
- Turn the handle to the side and this tool becomes a beam press which can press a 10-15 cm thick beam

	Part No.	Max. Breakaway (N)	Height (mm)	Width (mm)	Length (mm)	Weight (kg)
90 Degree Angle Stiffener 1200	8100961	1304,3	208	80	183	4,5
90 Degree Angle Stiffener 2400	81001000	3020,5	312,8	80	262	8,3
MagPress	8100935	4560,1	190,5	146	686	5,8



Accessories

Sheet Handler:

- Remove high/low when aligning plate
- 100 times faster than using dogs and wedges
- Center Sheet Handler over the seam, turn on, press to align and tack

Beam Press Accessory:

- Attaches to MLAY 1000x4 or 1000x6 lifting magnet
- Provides pry point for fitting stiffener beams
- Easy-carry handle allow for transportation by one or two people

Stiffener Alignment Tool:

- Mounts onto MLAY 1000x2 lifting magnet
- Provides stop for setting up stiffener beams
- Keeps beam at 90 degrees during fit-up

Heavy Sheet Leveler:

- Remove high/low during plate fit-up
- Levels up to 2" thick plate
- Easy-carry handle

	Part No.	Max. Breakaway (N)
Sheet Handler	8100361	8021,8 N
Stiffener Alignment Tool	8100554	no magnet
Beam Press Accessory	8100553	no magnet
Heavy Sheet Leveler	8100540	no magnet



No more handling hooks and chains when moving heavy sheets and beams. Designed to increase efficiency and safety, these lifting magnets can be used on a crane, hook or forklift. The replaceable poleshoes allow adaption to almost any kind of surface and shape. Last but not least, even the handling of thin sheets and material is easier than ever before due to full saturation on even thin targets.

MLAY 600

Applications: Lifting, Infrastructure, Shipyard

Powerful without the need for a power source! Heavy Lifters are built for heavy-duty lifting. The dual lift hook offers the stability to lift horizontally and a single hook to lift into a vertical position.

MLAY 600 Series

Perfect for small materials and light to medium lifting! These lifters are lightweight, have a small profile and feature our full swivel hook for lifting from the top or side. Each features a locking handle to ensure release of load is only intentional. Ideal for thinner steel, but hold thick steel just as well.

- Superior hold force on thin steel (70mm deep field)
- Compact, lightweight and easy actuation
- Lifts large flat sheets, beams and pipe
- Performs well on air gaps such as rust and dirt
- Customizable pole shoes to fit almost any application



8100364



High Heat variants available!

	Part No.	Max. Breakaway (N)	Height (mm)	Width (mm)	Length (mm)	Weight (kg)
MLAY 600	8100089	872,8	184	51,5	106	2,0
MLAY 600x2*	8100360	1520	170,9	165,4	221	5,2
MLAY 600x4*	8100364	3334,2	166,5	165,4	236	8,1

* Pole shoes included



8100089



8100364



8100364

MLAY 1000

Applications: Lifting, Infrastructure, Shipyard

MLAY 1000 Series

For heavy lifting, the MLAY 1000 Series lifters achieve full hold on approximately 1 in (25,4 mm) thick steel. These lifters feature our full swivel hook for lifting from the top or the side. Each lifter is manually activated and features a safety lock in both on and off position. The MLAY 1000 Series features a replaceable pole shoe, ideal for customizing to fit your application. Ideal for porous material and thick steel.



8100418



High Heat variants available!

	Part No.	Max. Breakaway (N)	Height (mm)	Width (mm)	Length (mm)	Weight (kg)
MLAY 1000	8100088	1480,8	253	71,5	147	5,2
MLAY 1000x2*	8100484	2971,4	267,5	195,6	318,8	10,8
MLAY 1000x3*	8100403	4059,5	264,5	195,4	271,3	16,6
MLAY 1000x4*	8100418	5403,5	260,7	195,4	271,3	16,6
MLAY 1000x6*	8100482	9041,7	253,3	195,4	350,3	20,5
MLAY 1000x12	8100549	1790	302	306,8	496	55

* Pole shoes included



Using Heavy Lifting Magnets on a beam system allows handling, de-stacking and positioning of large sheets and beams in different environments. Adapted to meet exactly customers requirements, this scalable beam system technology is the game changer in the heavy lifting and shipyard industry. Find out more about how to use our systems in order to drastically increase safety and efficiency in your work-shop.

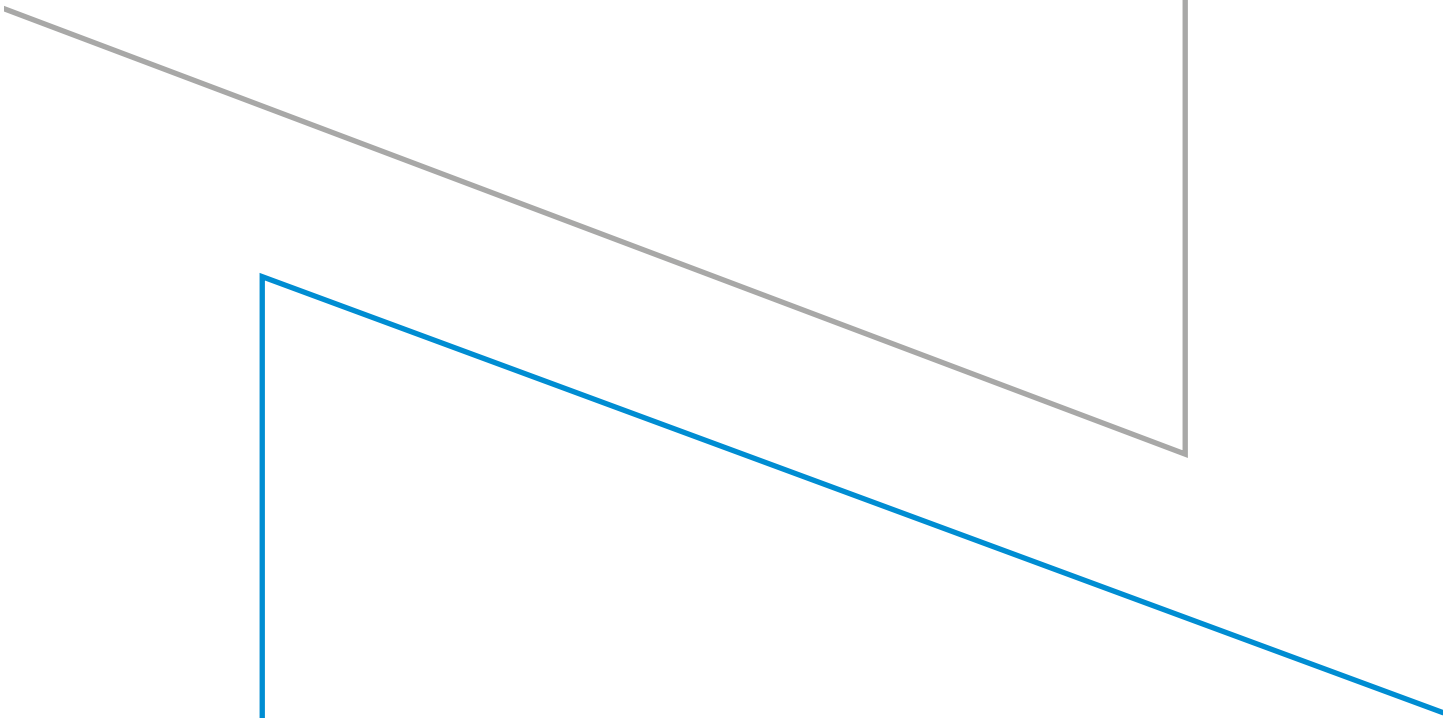

Telescoping Lift System

Perfect for lifting various sheet dimensions!

Telescoping Lift System offers adjustability based on the size of the plate being handled.

Shorter Plates: Activate only the inner magnets

- Medium Plates: Activate all the magnets with the telescopic arm in the closed position
- Long plates: Activate all the magnets with the telescopic arm in the expanded position
- Fail-Safe Technology: With loss of power, system will not drop plates

Heavy Lift Systems fully meet the standards of US ANSI ASME Standard B30.20 for below-the-hook lifting devices.

Model	Approx. System Weights (lbs)	Thickness (in)	Width Max. (in)	Length Min. (in)	Length Max. (in)	Lift Capacity (lbs)
8800955	3300	0.197	120	60	240	8800
8800956	5500	0.197	120	120	480	16500
8800957	5500	0.197	120	120	480	22000
8800958	7000	0.197	120	120	480	26000
8800959	8400	0.197	120	120	480	35000

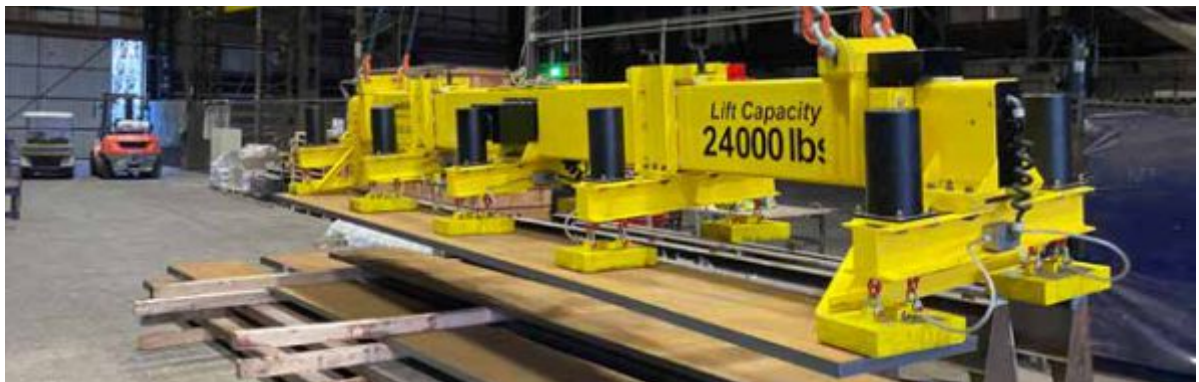

Fixed Lift System

Designed to lift your maximum plate size! Fixed Lift System can be configured with any number of cross members to fit your lifting needs. With zone control, independent activation of cross members allows for picking of varying plate sizes.

- Smaller Plates: Only inner magnets are switched on
- Larger Plates: All the magnets are switched on
- Fail-Safe Technology: With loss of power, system will not drop plates
- De-stack: Wide range of sheet thickness

No power available? No problem! Simply use the Battery Operated Lift System.

- Applications in Mobile Boom Truck, Fork Lift and Overhead Crane/Hoist
- Varied lifting capacities offered

Heavy Lift Systems fully meet the standards of US ANSI ASME Standard B30.20 for below-the-hook lifting devices.

Model	Approx. System Weights (lbs)	Thickness (in)	Width Max. (in)	Length Min. (in)	Length Max. (in)	Lift Capacity (lbs)
8800960	1650	0.197	120	20	240	4400
8800961	2650	0.197	120	100	240	8800
8800962	3300	0.197	120	100	480	11000
8800963	4000	0.197	120	100	480	16500
8800964	5500	0.197	120	100	480	22000
8800965	6200	0.197	120	100	480	26000
8800966	7300	0.197	120	100	480	35000

* Other options available upon request

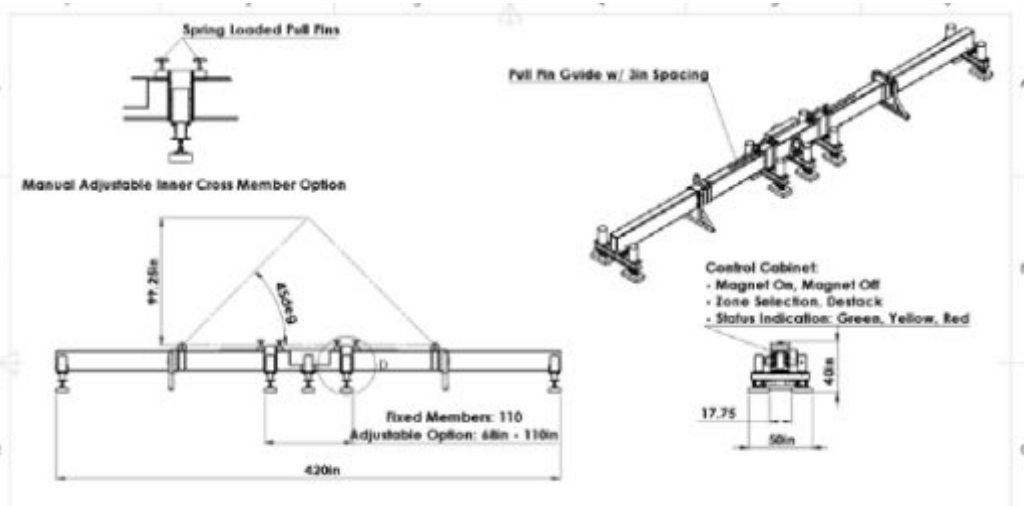



Custom Lifting Solutions

Part & Cut-Out Handling System

Handle multiple parts at once!

For the customer in need of safely and efficiently unloading multiple parts & cut-outs from their cutting table, the Part & Cut-out Handling System is the perfect solution. Designed to lift your maximum plate size for loading and to lift your part and cut-out after processing, the Part & Cut-Out Handling System, can be configured with any number of cross members to fit your lifting needs. With zone control, independent activation of cross members allows for picking of varying plate sizes.

Heavy Lift Systems fully meet the standards of US ANSI ASME Standard B30.20 for below-the-hook lifting devices.



Cordless Electric System

No power? No problem!

When wall or drop-down power is not available, the Cordless Electric System is the perfect solution. The CE systems can be used via overhead crane, boom truck and forklift. This versatile and compact design is powered by a 48V battery pack with a built-in charger and has approx. 300 cycles on a full charge. From 4ftx8ft up to 10ftx20ft plates, a variety of lifting capacities offered.

Applications: Mobile Boom Truck, Fork Lift and Overhead Crane/Hoist

Heavy Lift Systems fully meet the standards of US ANSI ASME Standard B30.20 for below-the-hook lifting devices.



Custom Lifting Solutions

Profile & Bundle Lift Systems

Safety & Efficiency!

When lifting profile and bundles, safety and efficiency is key.
The Profile and Bundle lift system is custom designed to fit your specific lifting requirements.

Applications: For handling pipe, I-Beams, H-Beams, billets

Heavy Lift Systems fully meet the standards of US ANSI ASME Standard B30.20 for below-the-hook lifting devices.



Mag-Kit (Retro Fit)

Mag Kit – Build your own system!

For the Customer seeking an economical solution, the Mag-Kit allows the customer to mount the magnets and controls to an existing spreader beam.

Applications: From small plates to large plates, multiple magnets can be combined to handle any plate size

The Kit Includes

- Magnets with mounting hardware
- Control Panel with wireless control

Heavy Lift Systems fully meet the standards of US ANSI ASME Standard B30.20 for below-the-hook lifting devices.



Working with wood and staying true to size has always been a challenge. Incorporating our Woodworking tools, this will be a thing of the past. Using this unique technology, we have designed various tools you guide and set up your shop in a professional way. Quick and easy workholding and guiding tools bring your shop on the next level – the Starter Kit is the best way to find out and try!

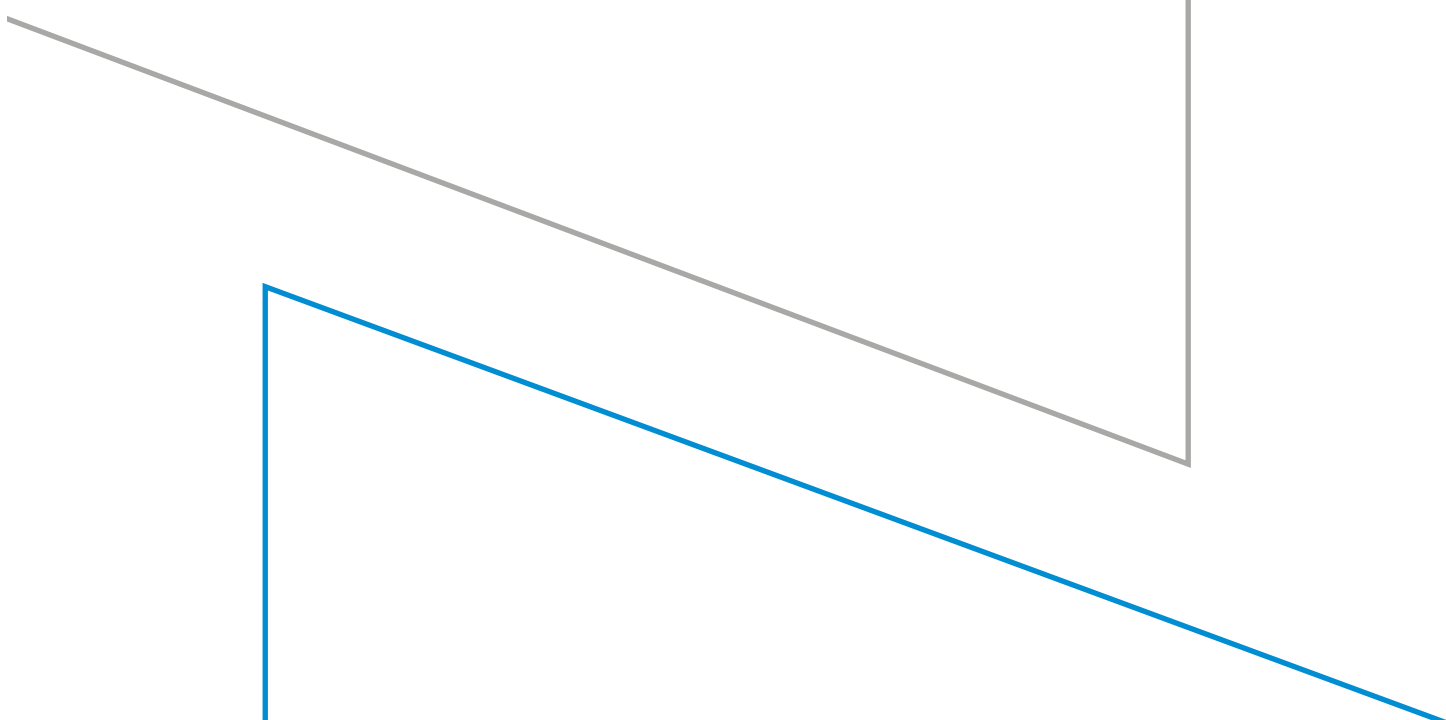

New products

Drill Press Fence

81101375

- Quick positioning & fine adjustment of the fence
- Magnets can be positioned at different points on the fence for optimal placement on small tables
- Sturdy vertical plate will not interfere with the drill chuck, even when drilling holes close to the fence
- The fence plate is 33cm long & 6,35cm high



81101373

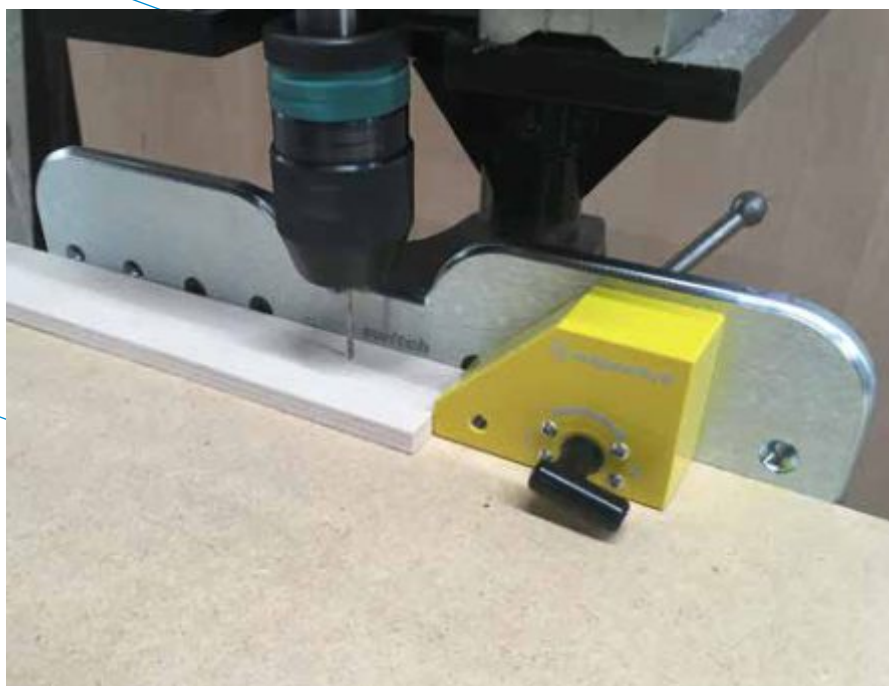

Drill Press Fence Pro

81101371

- Sturdy large vertical plate will not interfere with the drill chuck when drilling holes close to the fence
- Can be used as a bandsaw resaw fence
- Stop block that can be quickly be positioned flush with the drill press table or sacrificial material under the workpiece and can be stored out of the way when it is not needed
- The fence plate is 53,3cm long by 10,9cm high



81101371



MagJigs

Applications: Woodworking, Fixturing, Clamping, Welding

It's a kind of MagJig! Secures your fixture easily into place. Simply turn the knob and feel the magic. Drill a hole in a fixture and place the MagJig in to use for downward pressure clamping.

- Holds flat and round surfaces of steel
- 3/4" standoff for flush mount
- Designed with screw holes to add more security in a fixture
- Excellent for woodworking, welding and fabrication



8100377



High Heat variants available!

	Part No.	Max. Breakaway (N)	Height (mm)	Width (mm)	Length (mm)	Weight (kg)
Magjig60 Keychain	8100514	264,7	43	26,8	39,5	0,1
MagJig 60	8100818	264,7	43	26,8	39,5	0,1
MagJig 95	8110004	421,7	46,6	34	57	0,1
MagJig 150	8110005	961	52,1	44	67	0,1
MagJig 235	8100377	1039,5	78,3	60	67	0,5



Featherboards

Universal Featherboard

8110015

- Designed to work on any cast-iron table to hold down your work
- Works on both sides of the blade and even the fence
- Features two 20 mm MagJig magnets



8110015

Universal Featherboard Pro

81101303

- Provides strong featherboard force against the table saw fence in either left handed or right handed positions
- Wide base magnets and gaskets provide excellent grip even when placed over the table saw miter slot
- Two micro adjustable bump feet allow the tool to function as a versatile stop for cross cuts and slots



81101303



Starter Kit

8110134

A perfect entrée into the Workholding System!

- Once you have this tool, get all the other great tool attachments & simply mount to the base as needed
- Comes with: Universal Mounting Base, Reversible Featherboard Attachment, two MagJigs 150



Pro Table Featherboard

8110328

- Perfect for vertical and right side applications
- Push the flexible fingers against the workpiece and twist each knob to turn on/off



Featherboards

Vertical Featherboard with Risers

8110178

- Adds a dimension of dual plane workholding
- For use with the Woodworking Starter Kit & the Pro Table Featherboard*
- Mounts to the Reversible Featherboard Attachment, Universal Mounting Base and MagJigs*



8110178

Vertical Featherboard Pro

81101302

- A table saw safety attachment which pushes the workpiece down against the table
- Prevents ride-up and kickback
- Matches the height of the workpiece
- Can be paired with a second Pro Vertical Featherboard for downward pressure on a work piece before and after the saw blade



81101302



* each sold separately

Ultimate Thin Stock Jig

8110362

- Features a stepped side for most common sizes and a fixed roller bearing
- Extends forward for accurate repetitive ripping
- Ideal for thin stock hold down or infeed/outfeed a table saw
- Requires Woodworking Starter Kit*



8110362

Reversible Featherboard

8110131

- Lightweight woodworking featherboard is reversible for left and right hand feeds
- Perfect for infeed and outfeed applications
- Accommodates the Vertical Featherboard attachment and the Woodworking Starter Kit *



8110131

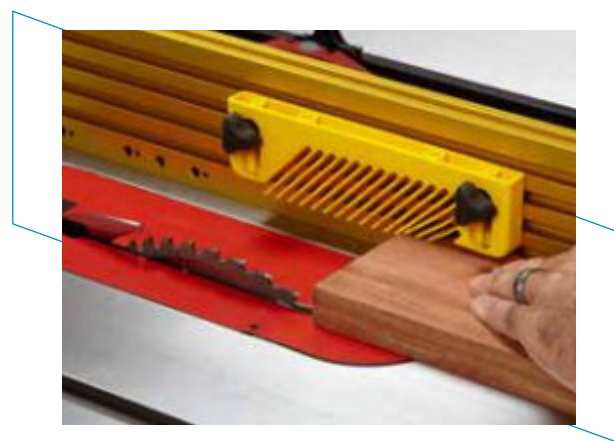

* each sold separately

Accessories

Universal Mounting Base

8110112

- The centerpiece of the Workholding System
- Simply add desired tool attachment, place on any steel or cast-iron tabletop & you are ready to go
- Additional tool attachments* are designed to fit the Universal Mounting Base



8110112

Universal Saw Indicator

81101326

- 2 in 1 tool: Miter slot to table saw blade alignment calibration & table saw fence micro adjustment indicator
- Measures alignment of the table saw blade relative to the table (and the miter slot) to allow fine adjustment of blade parallelism
- Measures very small changes in fence parallelism
- Indicator is attached via an adjustable slot, allowing it to slide to fit a wide variety of miter slot spacing



81101326

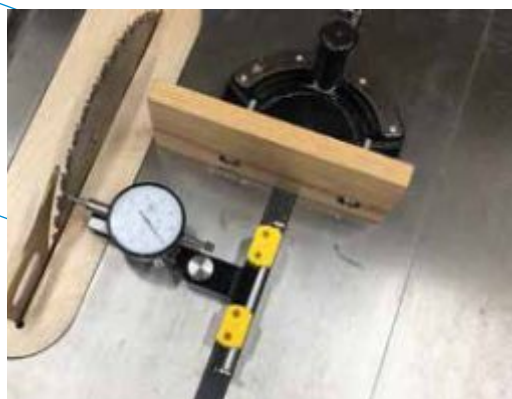

* each sold separately

Riser Kit for Multi Level Workholding

8110155

- Designed to be used with the Pro Table Featherboard & the Vertical Featherboard*
- Features 4 stackable risers to achieve multi level workholding and support
- Allows you to have an adjustable, stackable featherboard
- Helps protect against kickbacks in the vertical and horizontal plane, allowing greater safety and quality of cut
- Indicator is attached via an adjustable slot, allowing it to slide to fit a wide variety of miter slot spacing



8110155

Forstner Bit 30 mm & 40 mm

180098 & 180099

- 30mm and 40mm Forstner bits allow a hole to be drilled that will have the ideal fit to accommodate a Magjig 95 or 150
- Allowing precision Magjig custom fixtures and tools to be constructed



810098 & 810099



* each sold separately

Tracks & Guides

18" Universal Track

8110132

Easily and quickly set up a fence anywhere on a steel table!

- The track is aluminum and solid for heavy duty jobs
- Make your own jigs, fixtures, stops, fences, zero clearance fences
- Requires a Woodworking Starter Kit*



8110132

36" Universal Track

8110370

Easily and quickly set up a fence anywhere on a steel table!

- The track is aluminum and solid for heavy duty jobs
- Make your own jigs, fixtures, stops, fences, zero clearance fences
- Requires a Woodworking Starter Kit*



8110370



* each sold separately

Dual Roller Guide

8110130

- Dual set of roller bearings firmly supports the smooth gliding of wood through a blade
- Requires our Woodworking Starter Kit and mounts to the Universal Mounting Base and MagJigs *



8110130

Resaw Guide

8110125

- Designed with an angled infeed/ outfeed to allow for blade drift adjustment
- Roller bearing provides support and smoothly glides wood through a blade
- Requires a Woodworking Starter Kit *



8110125



* each sold separately

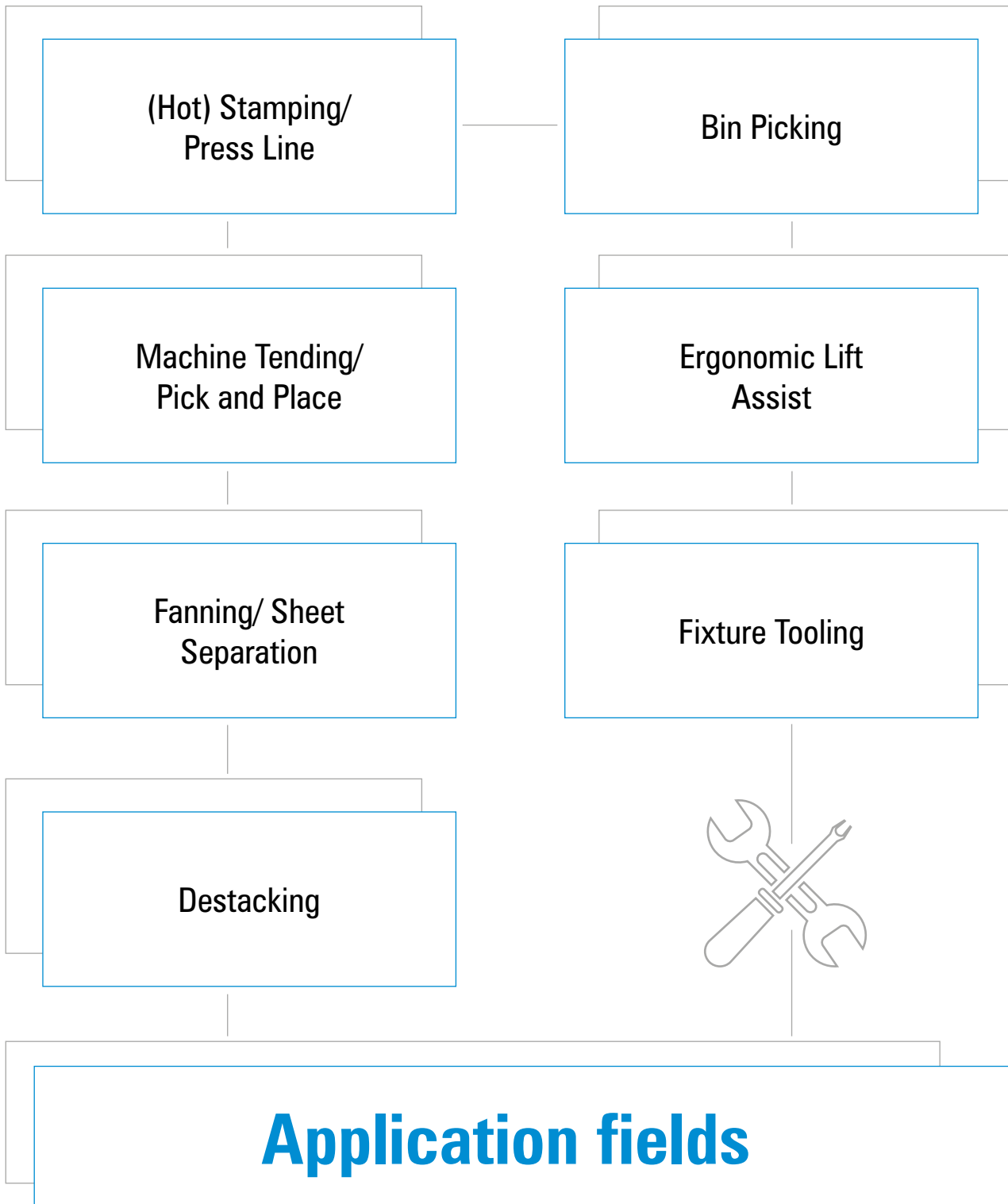

Customized solutions adapted to your needs will offer you:

- Space Reduction
- Less Energy Consumption
- Weight Reduction
- Cycle Time Reduction
- Fail-safe operation
- Easy integration
- Safer workplaces
- Cost savings

T-Series



J-Series

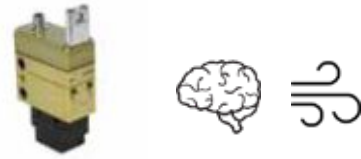

E-Series



ELAY-Series



D-Series



AR-Series



Play-Series



Sheet Fanner



 pneumatically operated

 electrically operated

 intelligent sensors

 manually operated

Description	Page number	Description	Page number	Description	Page number
MagSquare 165	8	Fixed Hand Lifter 400	28	Drill Press Fence	72
MagSquare 400	8	Dual Hand Lifter 235	28	Drill Press Fence Pro	73
MagSquare 600	8	Dual Hand Lifter 400	28	Magjig60 Keychain	74
MagSquare 1000	8	Hand Lifter 60 M	30	MagJig 60	74
MagMount 60 Keychain	10	Hand Lifter 60 CE	32	MagJig 95	74
MagMount 150	10	MagYoke	34	MagJig 150	74
MagMount 235	10	MagHook 25	36	MagJig 235	74
MagMount 235 UH	10	MagHook 40	36	Universal Featherboard	76
MagMount 300	10	Extenda-Lift 600	40	Universal Featherboard Pro	76
MagMount 300 UH	10	Extenda-Lift 1000	40	Starter Kit	77
MagMount 400	10	MagDolly	42	Pro Table Featherboard	77
MagMount 600	10	1,5 Ton Beam Jack	42	Vertical Featherboard with Risers	78
MagMount 1100	10	3 Ton Beam Jack	42	Vertical Featherboard Pro	78
300 Amp	12	6 Ton Beam Jack	42	Ultimate Thin Stock Jig	79
600 Amp	12	MagReach 400	44	Reversible Featherboard	79
800 Amp	12	90 Degree Angle Stiffener 1200	48	Universal Mounting Base	80
MagWheel 95	14	90 Degree Angle Stiffener 2400	48	Universal Saw Indicator	80
MagWheel 150	14	MagPress	48	Riser Kit for Multi Level Workholding	81
MagWheel 600	14	Sheet Handler	50	Forstner Bit 30 mm	81
MagWheel1000	14	Stiffener Alignment Tool	50	Forstner Bit 40 mm	81
MagTether 300	16	Beam Press Accessory	50	18" Universal Track	82
MagTether 600	16	Heavy Sheet Leveler	50	36" Universal Track	82
MagTether 1000	16	MLAY 600	54	Dual Roller Guide	83
Mini Angle	18	MLAY 600x2	54	Resaw Guide	83
Multi Angle 400	18	MLAY 600x4	54		
Mini Multi Angle	18	MLAY 1000	56		
Mini Multi Angle with 300 Amp Ground Clamp	18	MLAY 1000x2	56		
MagVise 1000	20	MLAY 1000x3	56		
MagVise 1500	20	MLAY 1000x4	56		
Pivot Angle 150 Mini	22	MLAY 1000x6	56		
Pivot Angle 150 Max	22	MLAY 1000x12	56		
Pivot Angle 200	22	Telescoping Lift System	60		
90° Angle 165	24	Fixed Lift System	62		
90° Angle 400	24	Small Plate Lift	64		
90° Angle 600	24	Part & Cut-Out Handling System	66		
90° Angle 1000	24	Cordless Electric System	67		
Boomer Angle 150	26	Profile & Bundle Lift Systems	68		
Boomer Angle 400	26	Mag.Kit (Retro Fit)	69		
Boomer Angle 600	26				
Fixed Hand Lifter 235	28				

Article No.	Page number	Article No.	Page number	Article No.	Page number
8100494	8	8100810	28	8800964	62
8100238	8	8100821	28	8800965	62
8100106	8	8100822	28	8800966	62
8100099	8	8100359	30	81101375	72
81001291	10	8100487	32	81101371	73
8100579	10	8100551	34	8100514	74
8100451	10	8100012	36	8100818	74
8100695	10	8100006	36	8110004	74
8100595	10	8100025	40	8110005	74
8100696	10	8130177	40	8100377	74
8100523	10	8100433	42	8110015	76
8100580	10	81001245	42	81101303	76
81001397	10	8800605	42	8110134	77
8100746	12	81001171	42	8110328	77
8100747	12	81001332	44	8110178	78
8100552	12	8100961	48	81101302	78
8100401	14	81001000	48	8110362	79
8100074	14	8100935	48	8110131	79
8100075	14	8100361	50	8110112	80
8100250	14	8100554	50	81101326	80
8100111	16	8100553	50	8110155	81
8100077	16	8100540	50	180098	81
8100051	16	8100089	54	180099	81
8100352	18	8100360	54	8110132	82
8100438	18	8100364	54	8110370	82
8100350	18	8100088	56	8110130	83
8100351	18	8100484	56	8110125	83
8100450	20	8100403	56		
8100897	20	8100418	56		
81001269	22	8100482	56		
81001215	22	8100549	56		
8100367	22	8800955	60		
8100548	24	8800956	60		
8100454	24	8800957	60		
8100495	24	8800958	60		
8100503	24	8800959	60		
8100091	26	8800960	62		
8100453	26	8800961	62		
8100090	26	8800962	62		
8100795	28	8800963	62		

Industrial Magnets

GALAȚI

Str. Traian nr. 444
Tel: 0236 412 088; 0236 466 960
Fax: 0236 334 048
E-mail: galati@pentagonromania.ro

BUCUREȘTI - OTOPENI

Str. Calea Bucureștilor nr. 1
Tel/Fax: 021 3520 267
E-mail: bucuresti@pentagonromania.ro

CONSTANȚA

Șos. Mangaliei nr. 76
Tel/Fax: 0241 693 926
E-mail: constanta@pentagonromania.ro

TULCEA

Str. Spitalului nr. 19, bl. 19, parter
Tel/Fax: 0240 511 098
E-mail: tulcea@pentagonromania.ro

BRĂILA

Calea Călărașilor nr. 256, bl. N, parter
Tel.: 0748 159 336
E-mail: braila@pentagonromania.ro

TIMIȘOARA

Calea Șagului nr. 165
Tel.: 0759 027 330
E-mail: vest@pentagonromania.ro

Reprezentanți zonali

Zona Ardealului

Tel. 0751 020 039
E-mail: centru@pentagonromania.ro

Zona Moldovei

Tel. 0748 171 592
E-mail: est@pentagonromania.ro

Zona Munteniei

Tel. 0748 171 554
E-mail: sud@pentagonromania.ro

www.pentagonromania.ro



since 1991

PENTAGON

Întotdeauna Soluția Potrivită